

A-A

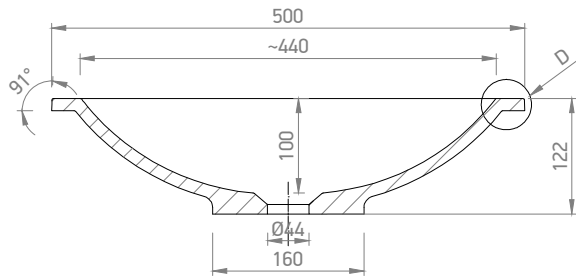

D 1:2

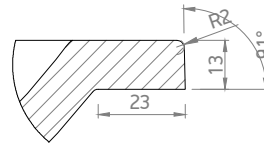

B-B

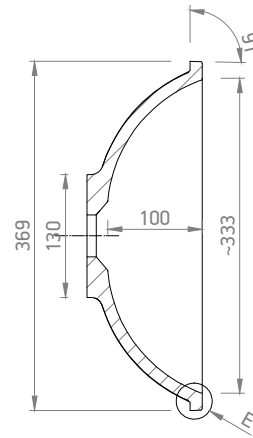
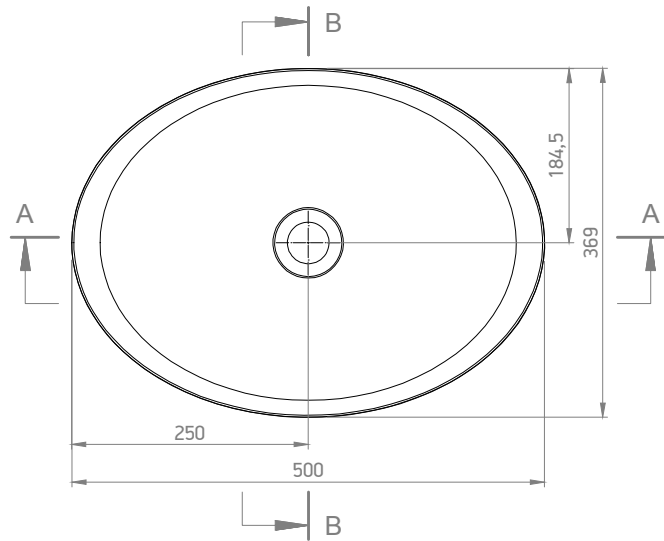
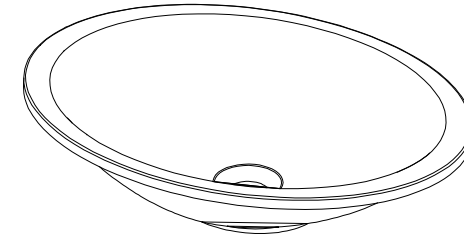

E 1:2

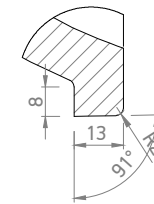

	Name:	
	MARA 50x37	
MARMY www.marmy.eu	Item NR.:	
	6 229 23 05 10 18	
Weight:	Visible height:	Scale:
5 kg	1,5 cm	1:8